

An experimental investigation of performance levels in a new root crown cleaner

V. Bulgakov¹, S. Pascuzzi², M. Arak³, F. Santoro², A.S. Anifantis², Y. Ihnatiev⁴
and J. Olt^{3,*}

¹National University of Life and Environmental Sciences of Ukraine, 15 Heroyiv Oborony street, UA03041 Kyiv, Ukraine

²Department of Agricultural and Environmental Science University of Bari Aldo Moro, Via Amendola, 165/A, IT70125 Bari, Italy

³Estonian University of Life Sciences, Institute of Technology, Kreutzwaldi 56, EE51006 Tartu, Estonia

⁴Tavria State Agrotechnological University, 18 B, Khmelnytsky Ave, UA72310 Melitopol, Ukraine

*Correspondence: jyri.olt@emu.ee

Abstract. For the purposes of carrying out field experiments using the vertical-type cleaner with its elastic cleaning blades to remove haulm residues from the crowns of standing roots, the programme for this process and the technique behind it have both been developed by basing the process on the measurement of the volume of haulm residues that are left on the root crowns after they have been cleaned by a cleaning tool that operates at pre-set values in terms of its translational velocity, its height above the soil surface, and its rate of revolution. In addition, the cleaner's energy-and-force performance has also been determined. In this process, the new laboratory and the field experimental unit have been put together. The unit comprises a rear-mounted root crown cleaner of the rotary type with a vertical axis of rotation. During the field experiments, the general-purpose tractor which carries it moves at a pre-set velocity as registered by the track measuring wheel; the general height of the cleaning tool's position is set within the specified range by the use of two pneumatic feeler wheels that are equipped with adjustment mechanisms. The results of the completed investigations have been statistically processed with the use of the regression analysis and correlation analysis methods. On the basis of the developed multiple-factor experiment technique, empirical mathematical models have been generated in the form of regression equations for the process of cleaning the crown's of sugar beet roots. In accordance with the results of the calculations, it has been established that the translational velocity of the implement has the greatest level of impact on the volume of haulm residue that remains on the spherical surfaces of root crowns after cleaning. The rate of rotation for the vertical cleaning rotor and its height above the soil surface which are controlled by the two pneumatic feeler wheels have a lesser effect on the process under consideration.

Keywords: cleaner, elastic blade, harvesting, haulm, sugar beet root, experimental unit.

INTRODUCTION

The topping of standing roots and the removal of haulm residues from their crowns is a key problem in the work process where this involves sugar beet harvesting

(Vasilenko, 1996; Gruber, 2005; Wang & Zhang, 2013; Gu et al., 2014). It has been established by previous research that within the context of state-of-the-art sugar beet topping technologies which require shearing off the upper parts of the root crowns, perhaps around 14–17% of the sugar-bearing mass is lost. In view of the above, the problem of removing haulm and cleaning the root crowns of sugar beets of haulm residues without losing any sugar-bearing mass is an economically justified research and development problem which should be of current concern. In order to be able to resolve said problem, it is necessary to develop a design of crown cleaning unit which not only provides for the cleaning of standing root crowns of haulm residues, but one which also features the design and technology embodiment that ensures that the quality and cost-performance indices of the operation are both increased. It is also necessary to develop a technique that can be used in experimental investigations into the cleaning unit that is under consideration, to carry out the comprehensive field testing of that unit, and then process the results of said field studies with the use of a PC in order to verify its technological and process properties. Providing a solution to the aforementioned tasks gives this paper its relevancy.

The scientific and practical problems that have been set out when it comes to cleaning the crowns of standing roots of haulm residues and other plant impurities that may be present in the inter-row spaces for sugar beet plantations after shearing off the bulk of the haulm from the roots are areas that can be solved through the development and implementation of modular-design tractor-implementation units - the modular concept provides some important advantages in the application of units under production conditions (Bulgakov, 2011).

A definitive contribution to the theory behind and practice of the process of post-cleaning standing root crowns of haulm residues was made at various times by the following scientists and design engineers (Pogorely et al., 1983; Pogorely et al., 2004; Bentini et al., 2005; Wu et al., 2013; Zhang et al., 2013, Bulgakov et al., 2016; Bulgakov et al., 2017, etc).

At the same time, the fundamental theoretical and field experiments which were carried out by the aforementioned authors as well as the specific relations between the parameters of the work process that are under consideration and the practical results of their application that have been obtained as a result are not sufficient for the substantiation of the design and process parameters and the operating modes of the newly-designed cleaning unit.

The aim of the study was to improve the quality of the work process when it comes to cleaning root crowns of haulm residues with the use of the new cleaning unit through the development of the improved technique of obtaining results from the experimental investigations that have been carried out for the estimation of the rational parameters of the process.

MATERIALS AND METHODS

The subject of the experimental investigations is the roots, haulm, and the work process that is required to remove haulm residues with the use of the newly-designed cleaning unit with a vertical drive shaft. The schematic model of the cleaning unit that is under consideration is presented in Fig. 1.

The relation between the design and kinematic parameters and the operating modes of the cleaning unit and its performance quality levels is the subject matter of these experimental investigations.

Therefore, in the quest for the further improvement of tools for root crown post-cleaning and the estimation of the performance quality levels of the tools in real operational conditions (depending upon the plant development status, the uniformity of root positioning in the rows, the kinematic modes of operation, and the parameters for being able to adjust the tools for the work process), standard experimental investigation practices have been used, and case-specific field testing procedures have also been developed.

As a result of processing the *a priori* information and carrying out theoretical investigations and expert analysis, it has been established that the principal input parameters (variable factors) in the experimental

investigations are the rotation rate for the vertical drive shaft with its cantilevered elastic cleaning blades, the travel rate of the cleaning unit, and the position of the cleaning tool above the soil's surface level. The other parameters that describe the operation of the cleaning unit that is under consideration as well as the characteristics of the conditions under which the investigations are carried out are fixed but controlled factors.

In order to determine the indicators of the agronomical appraisal of the beet root plantation, in the field that features a relatively smooth relief and a stable yield, test plots have been marked off, each plot consisting of several rows with a length of at least 25 m planted with sugar beet, and in those plots field experiments have been carried out using fivefold replication.

The biological yield has been recorded with the use of blanket gathering and the weighing of the roots of sugar beets from the test plot with a total area of 27 m², measuring 1.3 m widthwise (incorporating three rows) and 30 m lengthwise (taking into account the fivefold replication of each experiment).

The operational quality of the unit - in terms of cleaning root crowns of haulm residue has - been evaluated with the use of the procedure that is described here. Firstly, the haulm of each test plot is gathered using a commercial haulm-gatherer, which carries out the process of the blanket shearing-off of the haulm without feelers and supports across the entire operating span and without post-cleaning the root crowns of any haulm residues. Next, the indicators are determined and recorded for quality in terms of blanket shearing-off and the removal of the bulk of the haulm herbage. In order to obtain a more in-depth assessment of the quality of the operation of the new cleaning unit, the haulm gatherer's haulm cutting tool is set up for a height of cutting which ensures that the

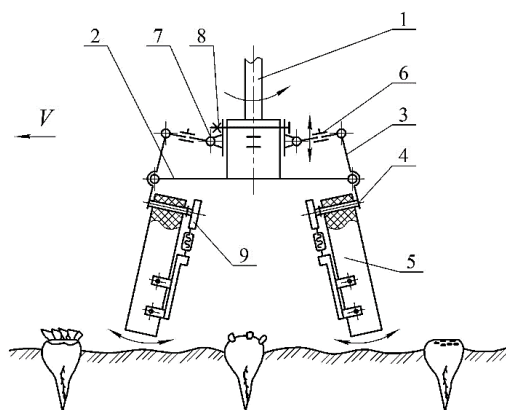

Figure 1. Design and process schematic model for a unit for cleaning root crowns of haulm residues (Bulgakov et al., 2018): 1 – vertical shaft; 2 – disk; 3 – double-arm lever; 4 – axles; 5 – blade; 6 – articulated arm; 7 – slide; 8 – lock; 9 – blade rigidity control unit.

wasted mass of the roots does not exceed 5.0%. At the same time, the amount and degree of the damage are both measured where it is inflicted on the sugar beet root crowns. This measurement process is carried out in accordance with the following formula:

- slightly damaged roots of sugar beets are classed as being those roots in which the cracks and chips on the crowns have a depth of less than 10 mm;
- severely damaged roots are classed as those roots in which chips and cracks (nicks) on the crowns are deeper than 10 mm.

During the experimental investigation of the newly-designed cleaning unit, the vertical position of the cleaning shaft with its elastic blades is changed so that the cleaning blades are situated at the level of the reference surface - 0 cm (in practice this means touching the beet root crowns), and above the reference surface that is formed by the root crowns, that is at heights of 2 cm and 4 cm above the soil's surface level. It ought to be noted that the lower setting for the cleaning blades relative to the soil surface results in a lower quality of root crown cleaning of haulm residues, knocking out roots from the soil and increasing energy consumption during the work process that is under consideration.

The samples are taken after root crown cleaning has been completed, with fivefold replication at every setting of the cleaning blade elevation process and at operating travel speeds of $V_p = 1.0; 1.5, \text{ and } 2.0 \text{ m s}^{-1}$ for the cleaning unit. The above conditions during the experimental investigation are applied along with switching between three values for the angular velocity ω of the cleaning tool's rotation - this being the vertical drive shaft: $\omega = 46.9, 56.5, \text{ and } 76.8 \text{ rad s}^{-1}$ (448 rpm, 540 rpm, and 734 rpm respectively).

Prior to carrying out a run by the cleaning unit, two similar contiguous rows of planted sugar beet are selected. A one metre-long frame is laid over one of them in such a manner that it encloses the row of sugar beet roots on both sides (Fig. 2).



Figure 2. Assessing the degree of sugar beet root crown cleaning.

After that, all of the haulm residues on the root crowns are cut off manually and are weighed on electronic scales with an accuracy of $\pm 0.1 \text{ g}$. The next step is to evaluate the quality of the cleaning unit's operations. To that end, upon the completion of the measurements, on the adjacent, similar row of planted

beet roots, the root crowns are cleaned by the cleaning unit. Then, the frame is laid over that cleaner-processed plantation row (opposite the previous place in which measurements were taken), and a comparative analysis of the degree of root crown cleaning of haulm residues is carried out by means of collecting and weighing the haulm residues. For that purpose, all haulm residues which remain on those root crowns that have already been cleaned (root crowns already cleaned by the cleaning unit) are manually cut off and are accurately weighed. When comparing the weighing data that was obtained previously and then again after the run by the cleaning unit, final results are arrived at which indicate the efficiency of root crown cleaning of haulm residues.

The degree of root crown cleaning of haulm residues is calculated with the use of the following Eq.:

$$\delta = \frac{M - M_o}{M} \cdot 100\% \quad (1)$$

where δ – is the degree of root crown cleaning, %; M – mass of haulm residues before the run by the cleaning unit; M_o – mass of haulm residues after the run by the cleaning unit.

From this it can be found that haulm residues per running metre (g m^{-1}) that remain on the beet root crowns after the cleaning shaft with its elastic cleaning blades has passed over them is the indicator that specifies the quality of the operation of the root crown cleaning unit. This parameter has been chosen as the function of optimisation - the dependent variable in this multi-factored experiment.

It is already well-known that the velocity of the translation of the cleaning unit and the rate of rotation of its tool are in a two-way interrelation, which is considered as being the kinematic mode of operation, and this is specified by the ratio of the cleaning blade's circumferential velocity to the velocity of the translation of the cleaning unit itself over the field.

In further statistical computation, the following factors are considered as being independent ones, which can be purposefully and quantitatively changed when carrying out field experiments:

- 1) the velocity of the translational motion of the experimental unit over the field;
- 2) the angular velocity of the rotational motion of the cleaning tool of the newly-designed cleaning unit;
- 3) the elevation of the line that is circumscribed by the lower end of the cleaning blade with reference to the soil's surface level.

The field experiments have been carried out in view of the problems that have been outlined above, and in accordance with the technique described above. For this end, the field experiment unit (Fig. 3) has been manufactured by modelling in full the operation of the newly-designed unit which cleans root crowns of haulm residues.

During the experimental investigations, the following indicators have been determined for the operational quality of the new root crown cleaning tool with its vertical drive shaft: the level of cleaning of haulm residues from root crowns and the sweeping of plant residues outside the operating zone within any planted row of sugar beet.

The experiments have been carried out in accordance with a programme which involves comprehensive fact-based experimentation. It ought to be noted that all items in this programme, which involves the investigation of the levels of quality inherent in

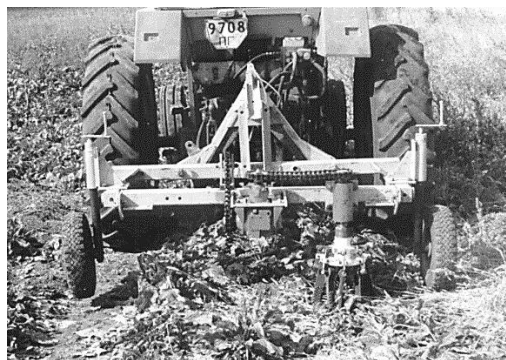

Figure 3. Experimental unit with attached implement for cleaning root crowns of haulm residues with a vertical cleaning drive shaft during field investigations.

the performance of the vertical cleaning tool, have been accomplished using fivefold replication, which totals:

$$N = 5P^k = 5 \cdot 3^3 = 5 \cdot 27 = 135 \text{ experiments} \quad (2)$$

In accordance with the preliminary theoretical studies (Bulgakov et al., 2018), three values are assumed for the cleaning unit's translation velocity; that is, the unit travels using the first, third, and reduced fifth gears of the carrying tractor, which is equivalent to the following values for the cleaning unit's speed of travel: 0.6, 0.9, and 1.9 m s⁻¹ respectively. The precise value for the translational motion velocity is monitored with the use of a track-measuring wheel that is mounted on the tractor.

The positioning of the cleaning tool with respect to the soil's surface level is determined by three positions. Due to the design of the multi-purpose experimental unit, the height at which the tool is carried can be adjusted within quite a wide range. The three following values are assumed for the elevation at which the tool's blades are mounted with respect to the soil's surface level: 0 m, 0.02 m, and 0.04 m, which is stipulated by the biological properties of sugar beet roots.

The angular velocity of rotation of the cleaning tool - its vertical drive shaft - is set at three levels: 46.9, 56.5, and 76.8 rad s⁻¹. Adjustments are made by changing the transmission ratio of the drive sprockets that are used in the vertical shaft's drive mechanism and by means of their respective replacement. The precise value for the angular velocity of rotation for the vertical shaft in relation to the number of teeth on the drive sprocket is calibrated in laboratory conditions with the use of a tachometer.

RESULTS AND DISCUSSION

After completing all of the experiments using fivefold replication in accordance with the comprehensive fact-based experimental programme, a total of 135 samples of haulm residues have been obtained. Each haulm residue sample that was obtained after running the cleaning unit with various parameters has been weighed using electronic laboratory scales.

The weighing results that were obtained have been sorted and inputted into the PC database, with statistical processing then being carried out. The results of the PC-assisted processing of the considerable amount of collected data are shown in Table 1.

Furthermore, the mathematical model for the subject of the research as a response function has been generated. In this function, the optimisation parameter is y – the haulm residues on the root crowns. The parameter represents the results of the experiment as a function of the following variable factors that assume different values during the experiments: x_1 – the velocity of the linear translational motion of the cleaning unit over the field; x_2 – the angular velocity of rotation of the cleaning tool; x_3 – the elevation of the cleaning blades with reference to the soil's surface level:

$$y = f(x_1, x_2, x_3). \quad (3)$$

When the correlations are studied, two principal issues can be seen to arise: it is necessary to determine the density - the relation between the factors in their effect on the optimisation parameter - and the shape of such a relation. In order to determine the density and the shape of relation, the use was made of regression and correlation statistical methods.

Correlation and regression analysis of the experimental data was carried out with the use of Analysis ToolPak in Microsoft Excel.

Table 1. Operational quality indicators for the root crown cleaning unit with its vertical drive shaft and elastic cleaning blades

Angular velocity of rotation (rad s ⁻¹)	Combined unit travel speed in field								
	0.8 m s ⁻¹			1.3 m s ⁻¹			1.9 m s ⁻¹		
	Elevation of cleaning blade (cm)								
	0	2	4	0	2	4	0	2	4
	Haulm residue, g m ⁻²			Haulm residue, g m ⁻²			Haulm residue, g m ⁻²		
734	4	1	5	12	14	0	43	83	79
	2	6	5	11	20	3	28	51	25
	9	23	12	5	14	17	37	44	23
	4	8	7	17	28	6	13	39	27
	0	19	6	9	10	11	9	38	21
540	8	4	24	10	32	60	9	2	116
	12	30	13	30	16	119	16	9	88
	16	9	21	4	28	72	5	19	61
	4	6	15	4	15	168	9	12	35
	5	4	53	21	13	128	19	19	169
448	80	64	234	41	9	52	2	18	14
	65	72	189	28	28	82	4	11	1
	57	94	142	29	29	79	2	11	28
	37	69	98	30	18	73	4	12	24
	83	52	126	38	34	111	7	18	8

The empirical dependencies have been computed with the use of the multivariate regression analysis in the form of a second degree polynomial with the possibility of being able to eliminate minor variables when carrying out the calculations. The computational work was done on a PC by means of dedicated software that was developed with the use of the experimental data computation technique.

The calculations that were carried out have resulted in a mathematical model being obtained of the volume of haulm residues on sugar beet root crowns, y , varying as a function of x_1 , x_2 , and x_3 which, after estimating the significance of the regression coefficients in accordance with Fisher's ratio test, assumes the following form:

$$y = 335.891 - 192.079x_1 - 5.075x_3 + 3.034x_1x_3 + 2.522x_2x_2. \quad (4)$$

Therefore the principal factors that have an effect on the process of post-cleaning root crowns of haulm residues are the velocity of the translational motion of the cleaner and the angular velocity of the rotation of its cleaning tool.

In order to determine the effect that the main design and kinematic parameters of the cleaner (its variable factors) may have on the optimisation parameter - in order to establish the relation between the volume of haulm residue on the root crowns and the angular velocity of the rotation of the cleaning drive shaft, the velocity of the cleaning unit's translational motion, and the elevation of the cleaning blades above the soil's surface level - the computer programme, STATISTICA-5.0 for Windows 95, has been used which has provided plotting for the graphical representation of the intermediate regression models in the form of quadratic response surfaces for the amount of sugar beet haulm residues as a function y_i of two variable factors x_i , with the third factor being

an invariable constant. The aforementioned response surfaces are presented in Figs 4, 5, 6, 7, 8, 9, 10, 11, and 12.

As a result of processing the experimental data, the intermediate regression equations which describe the effect that is produced by the velocity of the translational motion of the cleaning unit and the elevation of the cleaning blades above the soil's surface level at fixed values of the angular velocity of rotation for the cleaning tool have been generated, with these being, respectively, as follows:

$$\text{at } \omega_1 = 76.8 \text{ rad s}^{-1}$$

$$y_{1.1} = 30.817 - 58.533x_1 + 10.34x_2 + 30.687x_1x_1 + 1.445x_1x_2 - 2.883x_2x_2, \quad (5)$$

$$\text{at } \omega_2 = 56.5 \text{ rad s}^{-1}$$

$$y_{1.2} = -98.753 + 191.745x_1 - 32.195x_2 + 73.445x_1x_1 + 14.321x_1x_2 + 7.317x_2x_2. \quad (6)$$

$$\text{at } \omega_3 = 46.9 \text{ rad s}^{-1}$$

$$y_{1.3} = 157.991 - 156.173x_1 - 14.296x_2 + 42.444x_1x_1 - 18.547x_1x_2 + 5.75x_2x_2. \quad (7)$$

Through an analysis of the response surfaces of the dependencies between the volume of haulm residue on the root crowns and the velocity of the translational motion of the cleaning unit and the elevation of the cleaning blades above the soil's surface level as shown in Figs 4, 5, and 6, it has been established that the rational design and kinematic parameters of the work process which is involved in post-cleaning standing root crowns of haulm residues are found within the following ranges: the velocity of the translational motion of the cleaning unit - between 0.9–2.5 m s⁻¹, the and elevation of the cleaning blades above the soil's surface level - between 1.0–2.7 cm.

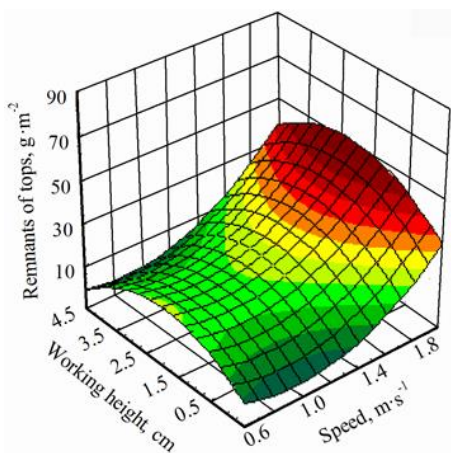

Figure 4. The response surface of haulm residues on root crowns against the speed of the cleaner and the elevation of the blades at the angular velocity of the cleaning tool's rotation of 76.8 rad s⁻¹.

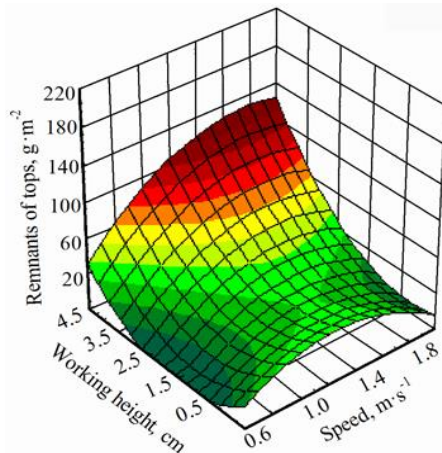

Figure 5. The response surface of haulm residues on root crowns against the speed of the cleaner and the elevation of the blades at the angular velocity of the cleaning tool's rotation of 56.5 rad s⁻¹.

When the angular velocity of the rotation of the vertical shaft rises from 46.9 to 76.8 rad s⁻¹ at the velocity of the translational motion of the cleaning unit equal to 1.5 m s⁻¹, the volume of haulm residues on the root crowns decreases from 32.36 to

6.41 g m⁻² with the elevation of the cleaning blades above the soil's surface level varying within 0–4 cm. Accordingly, at the velocity of the translational motion of the cleaning unit equal to 2.0 m s⁻¹ this figure increases from 12.6 to 16.5 g m⁻². Therefore changing the elevation of the cleaning blades above the soil's surface level produces only an insignificant effect on the optimisation parameter.

After processing the experimental data, the intermediate regression equations have been obtained that specify the influence of the velocity of the translational motion of the cleaning unit and the angular velocity of the rotation of its cleaning tool at the following fixed values for the elevation of the cleaning blades above the soil's surface level, with these being, respectively:

at $h_1 = 0$ cm

$$y_{2.1} = 559.575 - 156.264x_1 - 13.743x_2 + 3.475x_1x_1 + 2.265x_1x_2 + 0.081x_2x_2, \quad (8)$$

at $h_2 = 2$ cm

$$y_{2.2} = 657.136 - 239.272x_1 - 15.609x_2 + 24.424x_1x_1 + 2.72x_1x_2 + 0.094x_2x_2, \quad (9)$$

at $h_3 = 4$ cm

$$y_{2.3} = 236.016 - 180.451x_1 + 0.974x_2 - 30.222x_1x_1 + 4.13x_1x_2 - 0.071x_2x_2, \quad (10)$$

After analysing the response surfaces for the dependencies between the volume of haulm residues on the root crowns and the velocity of the translational motion of the cleaning unit and the angular velocity of rotation of its cleaning tool as shown in Figs 7, 8, and 9, it has been established that the rational design and kinematic parameters of the work process involved in the post-cleaning process are found within the following ranges: the velocity of the translational motion of the unit, which falls between 0.9–2.5 m s⁻¹, and the angular velocity of rotation of the cleaning tool, which falls between 63.0–81.0 rad s⁻¹.

When the elevation of the cleaning blades with reference to the soil's surface level rises from 0 cm to 4.0 cm at the velocity of translational motion of the cleaning unit which is equal to 1.5 m s⁻¹, the volume of haulm residues on the root crowns increases from 25.7 to 90.5 g m⁻² at the angular velocity of the cleaning blade's rotation of 46.9 rad s⁻¹. This provides an angular velocity of rotation that is equal to $\omega = 56.5$ rad s⁻¹ - between 18.04 and 62.9 g m⁻², and at $\omega = 76.8$ rad s⁻¹ - between 2.7 and 7.6 g m⁻².

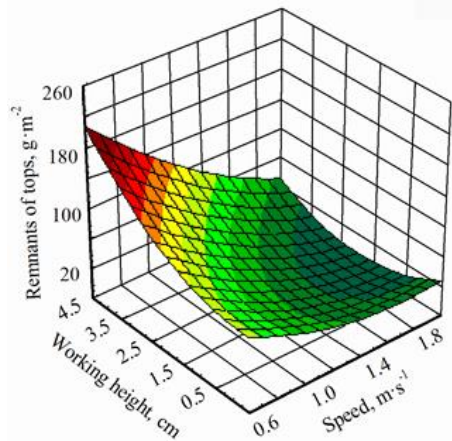

Figure 6. The response surface of the haulm residues on root crowns against the speed of the cleaner and the elevation of the blades at the angular velocity of the cleaning tool's rotation of 46.9 rad s⁻¹.

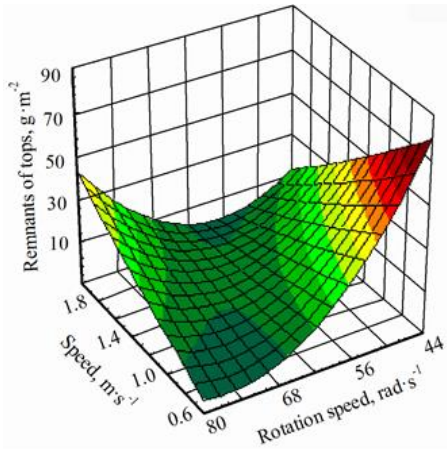

Figure 7. The response surface of haulm residues against the translational motion speed and angular velocity of the rotation of the cleaning tool at the elevation of the blades at 0 cm.

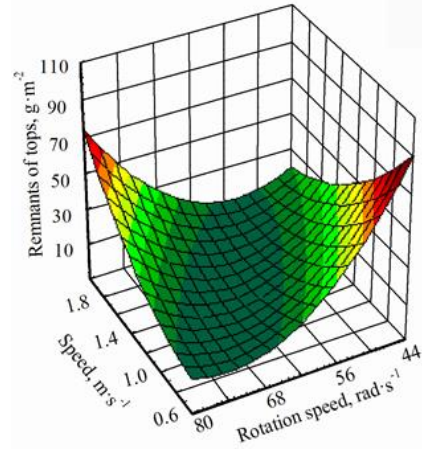

Figure 8. The response surface of haulm residues against the translational motion speed and angular velocity of the rotation of the cleaning tool at the elevation of the blades at 2 cm.

When the velocity of the translational motion of the cleaning unit rises to 2.0 m s^{-1} , the total volume of haulm residues on the root crowns increases from 18.4 to 62.9 g m^{-2} . Therefore an increase in the elevation of the cleaning blades above the soil's surface level from 0cm to 4.0 cm results in around a threefold growth in the volume of haulm residues on the root crowns, while the rise in the velocity of the translational motion of the cleaning unit reaches 2.0 m s^{-1} - a growth of about 3.4 times.

After processing the experimental data, the intermediate regression equations that specify the influence of the elevation of the cleaning blades above the soil's surface level and the angular velocity of the rotation of the cleaning tool at the following fixed values for the velocity of the translational motion of the cleaning unit have been obtained, with these being, respectively, as follows:

$$\text{at } V_1 = 0.8 \text{ m s}^{-1}$$

$$y_{3,1} = 1135.99 + 35.358x_1 - 35.721x_2 + 3.45x_1x_1 - 0.662x_1x_2 + 0.275x_2x_2, \quad (11)$$

$$\text{at } V_2 = 1.3 \text{ m s}^{-1}$$

$$y_{3,2} = -229.977 + 22.151x_1 + 8.454x_2 + 5.45x_1x_1 - 0.54x_1x_2 - 0.069x_2x_2, \quad (12)$$

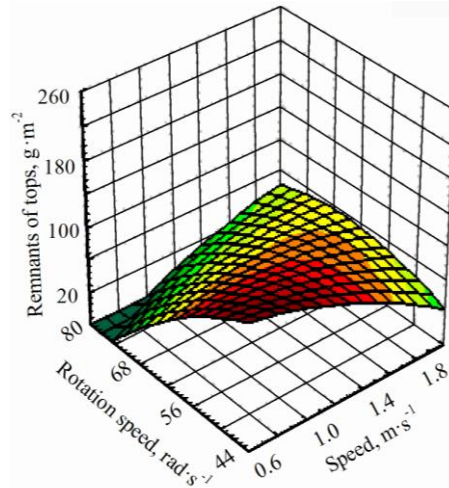

Figure 9. The response surface of haulm residues against the translational motion speed and angular velocity of the rotation of the cleaning tool at the elevation of the blades at 4 cm.

at $V_3 = 1.9 \text{ m s}^{-1}$

$$y_{3,3} = -430.304 + 1.745x_1 + 13.756x_2 + 1.283x_1x_1 - 0.156x_1x_2 - 0.102x_2x_2, \quad (13)$$

After analysing the response surfaces of the dependencies between the volume of haulm residues on the root crowns, the elevation of the cleaning blades above the soil's surface level, and the angular velocity of rotation of the cleaning tool as shown in Figs 10, 11, and 12, it has been established that the rational design and kinematic parameters of the work processes that are involved in post-cleaning are to be found within the following ranges: the elevation of the cleaning blades above the soil's surface level, between 0–1.21 cm, and the angular velocity of rotation of the cleaning tool, which is between 57.9–66.0 rad s^{-1} .

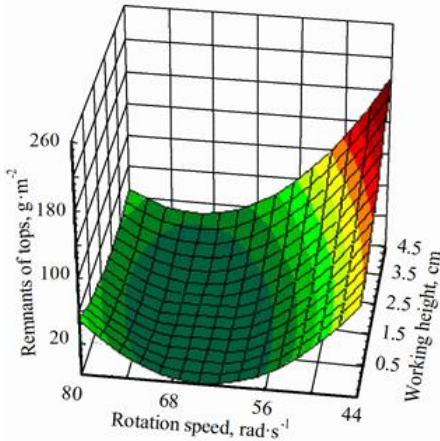

Figure 10. The response surface of haulm residues against the elevation of the blades and the angular velocity of the rotation of the cleaning tool at the velocity of the translation of 0.8 m s^{-1} .

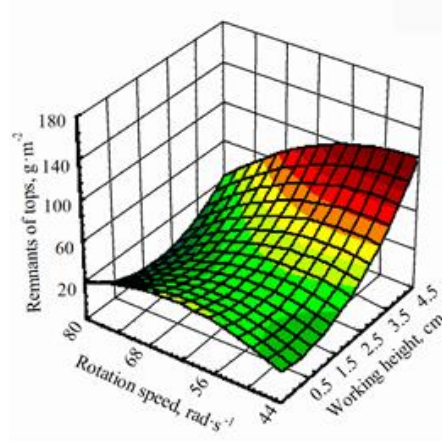

Figure 11. The response surface of haulm residues against the elevation of the blades and the angular velocity of the rotation of the cleaning tool at the velocity of the translation of 1.3 m s^{-1} .

When the velocity of the translational motion of the cleaning unit increases from 0.8 to 1.9 m s^{-1} at the elevation of the cleaning blades above the soil's surface level where this is equal to 2.0 cm, then the total volume of haulm residues falls from 58.1 to 3.1 g m^{-2} at an angular velocity of rotation for the cleaning tool of 46.9 rad s^{-1} . Further, when the angular velocity of rotation of the cleaning tool is increased to 56.5 and to 76.8 rad s^{-1} , the volume of haulm residues on the root crowns grows from 19.1 to 22.6 g m^{-2} and from 19.1 to 30.5 g m^{-2} respectively.

When the elevation of the cleaning blades above the soil's surface level is increased to 4.0 cm, the volume of haulm residues on the root crowns in practical terms does not change, and totals 58.1, 54.9, and 55.8 g m^{-2} at the velocity of the translational motion of the cleaning unit which is equal to 0.8, 1.3, and 1.9 m s^{-1} respectively, and the fixed angular velocity of the rotation of the cleaning tool which is equal to $\omega = 56.5 \text{ rad s}^{-1}$.

According to the results of the analysis of the quadratic response surfaces that has been presented in Figs 4–12, the optimum mode of operation for the cleaning unit has the parameters that are described below, subject to being able to minimise the volume of haulm residue on the root crowns (g m^{-2}), which is the principal quality indicator of the

root crown post-cleaning. The velocity of the translational motion of the cleaning unit has to be within the range of $1.5\text{--}2.0\text{ m s}^{-1}$. It has been established that operating the cleaning unit for the design that is under consideration outside the aforementioned translational motion velocity range, at lower speeds, results in damage being suffered by the sugar beet root crowns, while in the case of higher speeds the quality of the cleaning declines. The angular velocity of the rotation of the cleaning tool - its vertical drive shaft- on the cleaning unit of the design that is under consideration has to be within the range of $57\text{--}85\text{ rad s}^{-1}$. Any departure from said angular velocity range also results in a deterioration of the quality of post-cleaning or damage to the sugar beet root crowns. The elevation of the cleaning blades above the soil's surface level has no significant effect on the quality indicators of the process

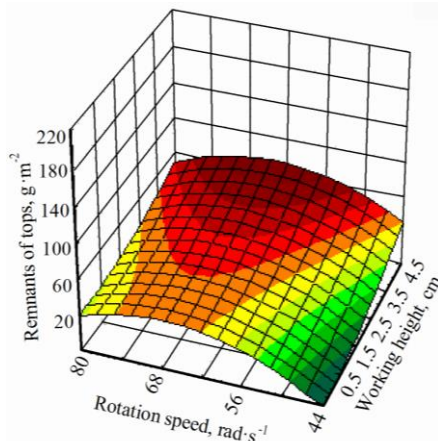

Figure 12. The response surface of haulm residues against the elevation of the blades and the angular velocity of the rotation of the cleaning tool at the velocity of the translation of 1.9 m s^{-1} .

in regard to post-cleaning root crowns of haulm residues. Nevertheless, a range of between $0\text{--}2\text{ cm}$ should be assumed as the most rational parameter range when it comes to positioning the cleaning blades above the soil's surface level.

Therefore, according to the results of the experimental research into the operation of the newly-designed cleaning unit which was carried out in real-life field conditions where sugar beet root crowns were cleaned of their haulm residues after a blanket feeler-free topping was carried out, the conclusion can be drawn that the operation quality indicators for the cleaning unit meet the existing agronomical requirements, which implies the expediency of its wide application in production conditions.

CONCLUSIONS

1. In the paper, the technique being used for experimental investigations into the unit that cleans root crowns of haulm residues has been substantiated. The technique involves investigating the effect that the modes of operation of the root crown cleaning unit have on the quality of being able to eliminate haulm residues - meaning an experimental determination in field conditions for the principal quality indicators in the performance of this design of cleaning unit.

2. It has been established that, in regard to the principal indicators for the quality of operation in field conditions, the unit that has been developed for cleaning standing root crowns of haulm residues not only meets agronomical requirements, but exceeds them.

3. The analysis of the regression equation that describes the effect of the main design and kinematic parameters regarding the degree of success of root crown post-cleaning of haulm residues has shown that the angular velocity of rotation of the cleaning

tool and the velocity of the translational motion of the cleaning unit are the principal factors that have an effect on the optimisation parameter.

4. After analysing the quadratic response surfaces, it has been established that the rational mode of operation for the cleaning unit, subject to minimising the post-cleaning quality indicator - in other words the volume of haulm residue on the root crowns (g m^{-2}) - is achieved within the following parameter ranges: the cleaning unit's travelling speed is between $1.5\text{--}2.0 \text{ m s}^{-1}$ and the angular velocity of the rotation of the cleaning tool is between $57\text{--}85 \text{ rad s}^{-1}$. The most rational parameter range for the elevation of the cleaning blades above the soil's surface level is between $0\text{--}2 \text{ cm}$.

5. Following the results that have been obtained in terms of the field experiments, it has been established that the extent of root crown cleaning of haulm residue is 95.9%, while the degree of sweeping haulm and plant residues which is outside the planted row of sugar beet is 99.96%, which exceeds the world's standard agronomical requirements for the process of post-cleaning sugar beet root crowns of haulm residue.

REFERENCES

- Bentini, M., Caprara, C. & Rondelli, V. 2005. Mechanical properties of sugar beet roots. *Transactions of the American Society of American Engineers* **48**(4), 1429–1439.
- Bulgakov, V.M. 2011. *Sugar beet harvesting machines*. Kiev: Agricultural Science, 351 pp.
- Bulgakov, V., Adamchuk, V., Arak, M. & Olt, J. 2018. The theory of cleaning the crowns of standing beet roots with the use of elastic blades. *Agronomy Research* **16**(5) 1931–1949. DOI:10.15159/AR.18.213
- Bulgakov, V., Adamchuk, V., Arak, M. & Olt, J. 2017. A theoretical study of haulm loss resulting from rotor toppler oscillation. *Chemical Engineering Transactions* **58**, 223–228. DOI: 10.3303/CET1758038.
- Bulgakov, V.; Adamchuk, V, Arak, M. & Olt, J. 2016. Theory of impact interaction between the feeler and standing sugar beet root crowns during their scalping. *Book of proceedings: VII International Scientific Agriculture Symposium "Agrosym 2016", Jahorina, October 6-9, 2016*. Ed. Dušan Kovacević. University of East Sarajevo, 63–70. DOI: 10.7251/AGRENG1607004
- Gruber, W. 2005. Trends in sugar beet harvesting. *Landtechnik* **60**(6), 320–321.
- Gu, F., Hu, Z., Wu, H., Peng, B., Gao, X. & Wang, S. 2014. Development and experiment of 4LT-A staggered-dig sugar beet combine. *Nongye Gongcheng Xuebao/Transactions of the Chinese Society of Agricultural Engineering* **30**(23), 1–9. DOI: 10.3969/j.issn.1002-6819.2014.23.001
- Pogorely, L.V. & Tatyanko, N.V. 2004. *Beet-harvesting machines: History, Construction, Theory, Prognosis*. Feniks, Kyiv, 232 pp. (in Ukrainian).
- Pogorely, L.V., Tatyanko, N.V. & Bray, V.V. 1983. *Beet-harvesting machines (designing and calculation)*. Tehnika, Kyiv, 168 pp. (in Russian).
- Vasilenko, P.M. 1996. *Introduction to agricultural mechanics*. Agricultural Education, Kiev, 252 pp. (in Russian).
- Wang, F. & Zhang, D. 2013. Design and experiment of disc-dig sugar beet combine. *Nongye Gongcheng Xuebao/Transactions of the Chinese Society of Agricultural Engineering* **29**(13), 7–14. DOI: 10.3969/j.issn.1002-6819.2013.13.002
- Wu, H., Hu, Z., Peng, B., Wang, H. & Wang, B. 2013. Development of auto-follow row system employed in pull-type beet combine harvester. *Nongye Gongcheng Xuebao/Transactions of the Chinese Society of Agricultural Engineering* **29**(12), 17–24. DOI: 10.3969/j.issn.1002-6819.2013.12.003
- Zhang, G., Xu, W. & Fan, S. 2013. Analysis and parameter optimization of adjustable beet top cutting mechanism. *Nongye Gongcheng Xuebao/Transactions of the Chinese Society of Agricultural Engineering* **29**(18), 26–33. DOI: 10.3969/j.issn.1002-6819.2013.18.004